

Push-in flow sensors // VTY

Push-in turbine with Hall effect sensor



Alternative hall effect sensor

VTY10/15/20/25



Product

- Flow sensor with high-quality sapphire bearing
→ Long-term stability
- 100% final test in water flow test bench
→ Guarantees a high level of operational safety
- Compact dimensions
→ Easy to integrate
- Flow straighteners
→ Hardly any requirement for inlet and outlet sections
- Clever bearing system
→ Excellent signal-output at low flow
- Sophisticated bearing flushing
→ Particularly insensitive to contamination

Flushing bore



The wet bearing resulting from the increase in centrifugal forces ensures cooling and flushing out of any contaminants and thus a long service life.

Quality

- SIKA's application experience about 25 years with approx. 2.5 million VTY turbine sensors in field
- OEM product developed and produced in Germany

Co-Engineering

- Product adaptation to customer requirements
- Provision of 2D and 3D data
- Provision of material test certificates acc. to customer product approvals in drinking water applications
- Test with the real customer hydraulics on SIKA test bench
→ Best possible measurement performance
→ Test reports available for customers

Can be integrated



Service

- SIKA flow lab - various endurance tests
→ Test reports can be shared with our customers
- VTY is ideal for usage in drinking water applications

At the beginning of the project, the requirements for the flow sensor technology are coordinated. Based on this, the possibilities of clever integration concerning the flow sensor technology will be presented by SIKA via 2D and 3D data.



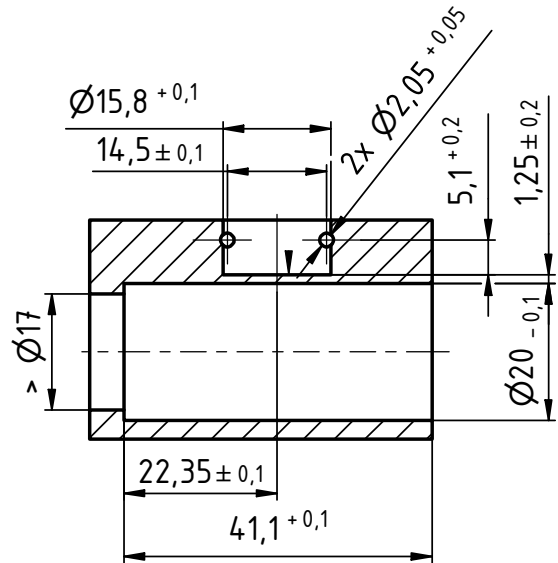
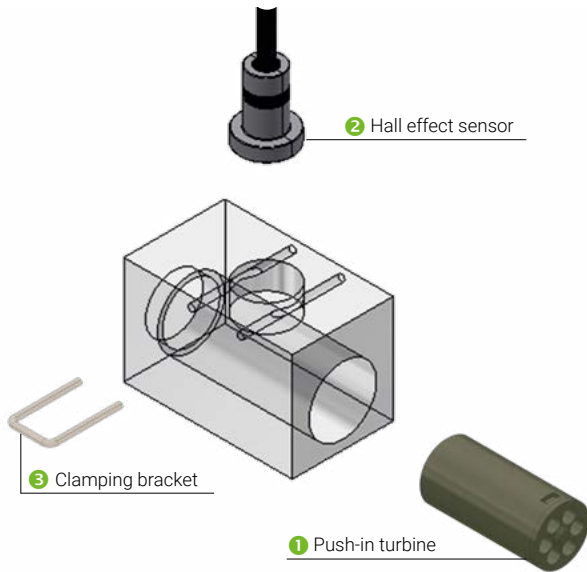

After the successful implementation of the project, SIKA supplies the components turbine capsule, hall-effect-sensor and clamping bracket. The OEM customer integrates these components into his fitting. From now on, the customer has an optimally adjusted and compact sensor unit

Installation space example VTY15



Technical data

1 Push-in turbine

Type	VTY10	VTY15	VTY20	VTY25
Flow range	1...30 l/min (60...1.800 l/h)	1...45 l/min (60...2.700 l/h)	1...60 l/min (60...3.600 l/h)	1...90 l/min (60...5.400 l/h)
Flow range	0.26...7.9 US gpm (15.9...476 US gph)	0.26...11.9 US gpm (15.9...713 US gph)	0.26...16 US gpm (15.9...951 US gph)	0.26...24 US gpm (15.9...1,427 US gph)
Accuracy	±1 % of range	±(1 % of range + 0.5 % of reading)	±(1 % of range + 1 % of reading)	
Repeatability	±1 %			
Signal output	From 0.7 l/min (42 l/h)	From 0.8 l/min (48 l/h)		
Signal output	From 0.18 US gpm (11.1 US gph)	From 0.21 US gpm (12.7 US gph)		
Medium temperature	0...90 °C (non-freezing)			
Medium temperature	32...194 °F (non-freezing)			
Nominal diameter	DN 10	DN 15	DN 20	DN 25
Nominal pipe size	¾"	½"	¾"	1"
Drinking water approvals				
	WRAS (approved product), Certificate no. 2111343	WRAS (approved product), Certificate no. 2012341	WRAS (approved product), Certificate no. 2310332	WRAS (approved product), Certificate no. 2309314
	KTW-BWGL: Product hygiene suitability for drinking water according to the 1+ system with external monitoring, Certificate no. Z-346843-21-Hy112 Rev.01			
	Kiwa Regulation 4 (KUKreg4) Certification, Certificate no. 2112709 (1)	Kiwa Regulation 4 (KUKreg4) Certification, Certificate no. 2012725	Kiwa Regulation 4 (KU-Kreg4) Certification, Certificate no. 2310747 (1)	Kiwa Regulation 4 (KU-Kreg4) Certification, Certificate no. 2308709 (1)
	NSF/ANSI 372, Certificate No. 8492 NSF/ANSI 61, Certificate no. N-8491 Available for: VY1030K50000YY		Approval pending	Approval pending
ACS (Attestation de conformité sanitaire)	Certificate no. 22 ACC LY 578			

Stated values may vary depending on geometry of fittings.

2 Hall effect sensor (not in contact with media)

Type	VTY10	VTY15	VTY20	VTY25
Nominal pulse rate	495 pulses/l	234 pulses/l	119 pulses/l	72 pulses/l
Nominal pulse rate	1874 pulses/gallon	886 pulses/gallon	450 pulses/gallon	273 pulses/gallon
Frequency output	Square wave frequency signal, NPN open collector			
Power supply	4.5...24 VDC			
Electrical connection	80 mm PVC cable with Molex Mini-Fit® Jr. plug connector (part number 0039014036) optional: 0.5 m PVC cable or 1 m PVC cable		3.2 inch single wire with Molex Mini-Fit® Jr. plug connector (part number 0039014036) optional: 19.7 inch PVC cable or 39.4 inch PVC cable	
Degree of protection EN 60529	IP65 and IP67 (Does not apply to plug connectors or open wire ends)			

3 Clamping bracket for VTY10, VTY15, VTY20 and VTY25

Dimensions [mm]	16.5 x 25, Ø 2
Dimensions [inch]	0.65 x 0.98, Ø 0.08
Material	Stainless steel

Typical pressure drop

VTY10

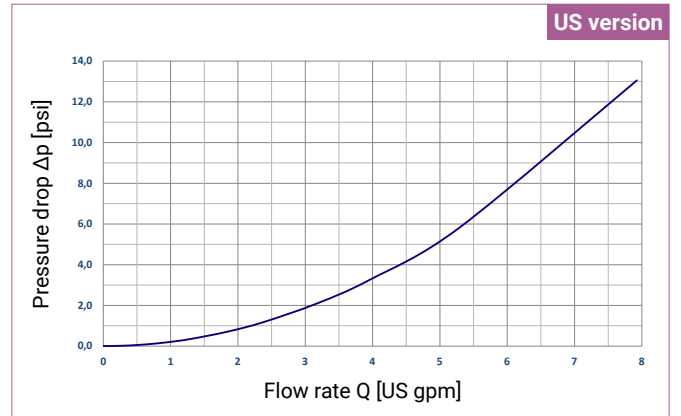
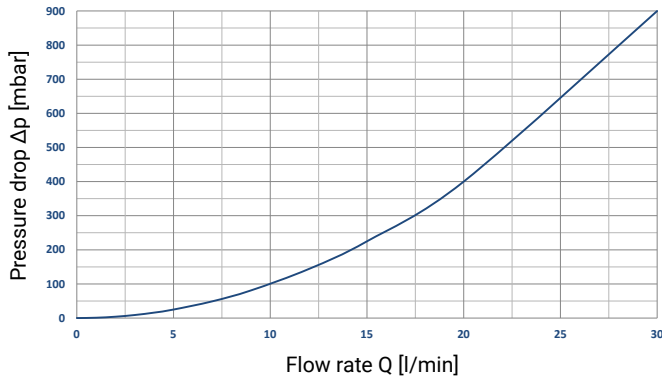

VTY15

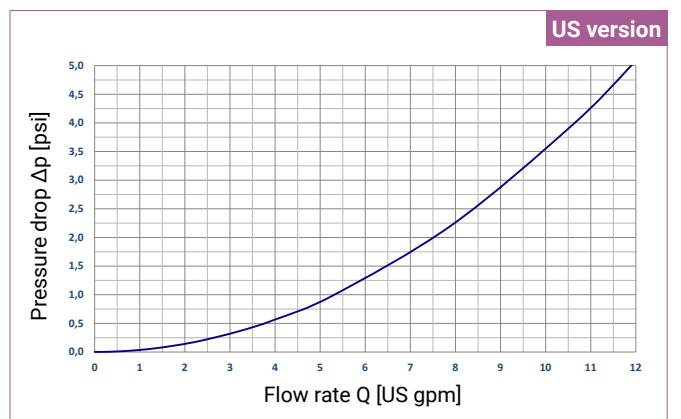
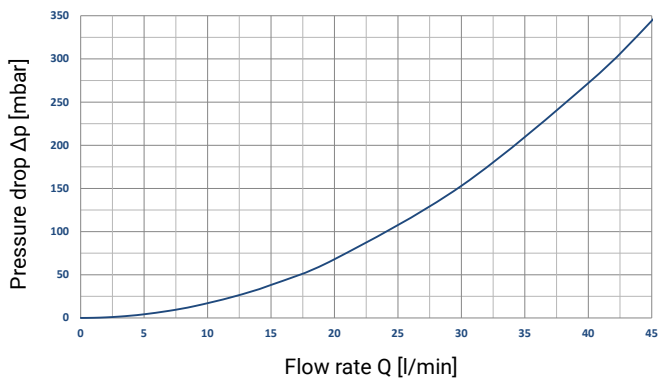

VTY20

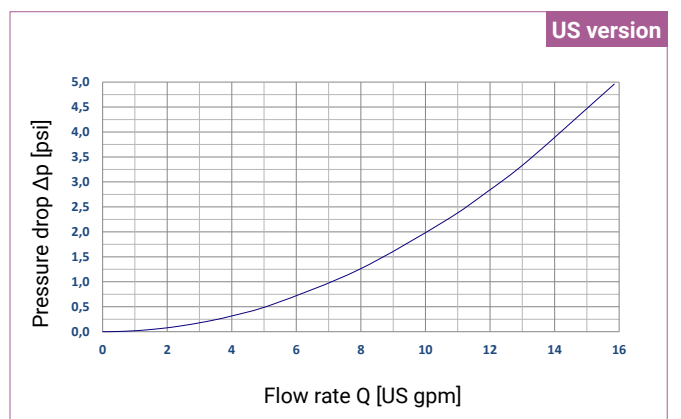
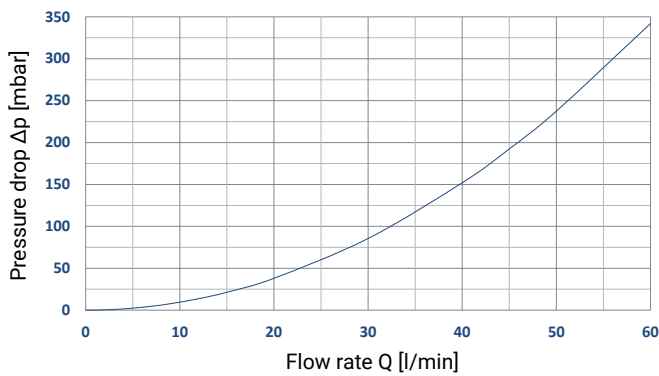

VTY25

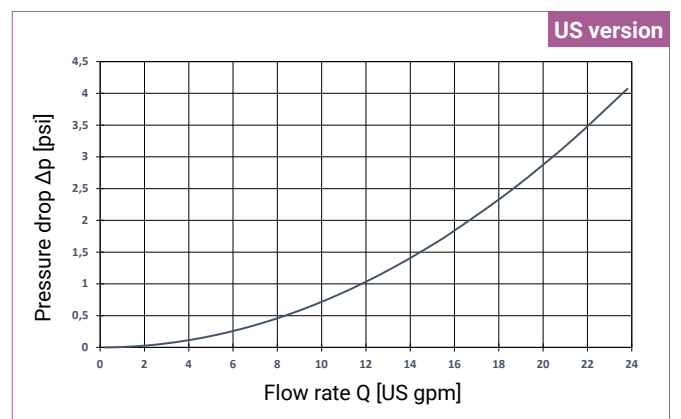
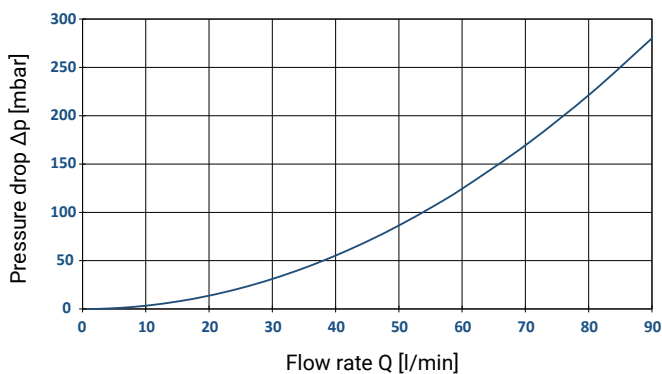

Pressure drop determined in SIKA standard pipe tee

Dimensions

VTY10 / VTY15 / VTY20 / VTY25
Push-in turbine

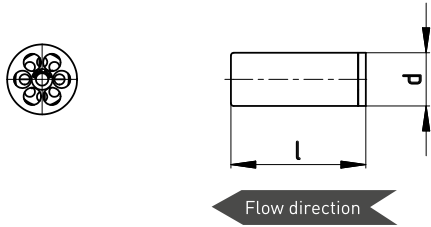

Dimensions [mm]		
VTY	l	d
10	38	Ø 15
15	43	Ø 19.7
20	43	Ø 24
25	44.5	Ø 27.9

Dimensions [inch]		
VTY	l	d
10	1.50	Ø 0.59
15	1.69	Ø 0.78
20	1.69	Ø 0.94
25	1.75	Ø 1.10

Hall effect sensor
Short design

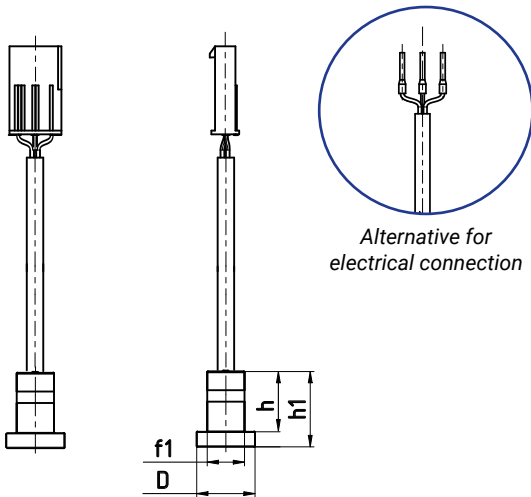

Dimensions [mm]			
D	h	h1	f1
Ø 15.6	16	20	Ø 10

Dimensions [inch]			
D	h	h1	f1
Ø 0.61	0.63	0.79	Ø 0.39

Hall effect sensor
Long design

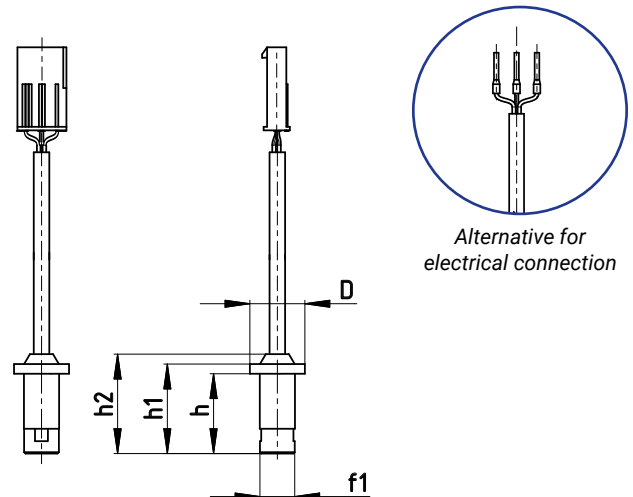

Dimensions [mm]				
D	h	h1	h2	f1
Ø 15.5	22.5	25.2	28	Ø 9.8

Dimensions [inch]				
D	h	h1	h2	f1
Ø 0.61	0.89	0.99	1.10	Ø 0.39

Materials

Materials in contact with fluid

Type	VTY
Push-in turbine	
Turbine body	PPE+PS 30 % glass fibre reinforced
Rotor	PPE+PS 30 % glass fibre reinforced
Magnet	Hard ferrite
Shaft	Stainless steel / Hard metal
Axial bearing	Sapphire
Radial bearing	PEEK

Wiring and pin assignment

Wiring

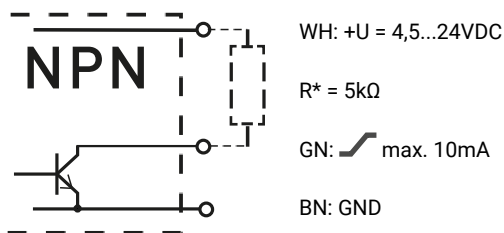

* Recommended pull-up resistance R ~ 5kΩ

Colour code

WH = white
 GN = green
 BN = brown
 R = resistance

Pin assignment Molex Mini-Fit® plug

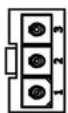

PIN3 = GN: max. 10mA
 PIN2 = BN: GND
 PIN1 = WH +U = 4,5...24VDC

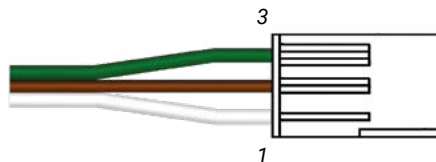

Article numbers

Push-in turbine VTY

Type	Article number
VTY10	VY1030K50000YY
VTY15	VY1545K50000YY
VTY20	VY2061K50000YY
VTY25	VY2590K50000YY

Hall effect sensor

Hall effect sensor - short design	Article number
 80 mm (3.2 inch) PVC cable with Molex Mini-Fit® Jr. connector 0.5 m (19.7 inch) PVC cable 1 m (39.4 inch) PVC cable	VY0000K8HNX6YY VY0000K8HN05YY VY0000K8HN10YY

Hall effect sensor - long design

 80 mm (3.2 inch) PVC cable with Molex Mini-Fit® Jr. connector 0.5 m (19.7 inch) PVC cable 1 m (39.4 inch) PVC cable	VY1030K8HNX6YY VY1030K8HN05YY VY1030K8HN10YY
---	--

Clamping bracket

Clamping bracket for hall effect sensor VTY	XVT3214
---	---------

Service - Test in the test bench

Article	Article number
Tests in provided customer hydraulics including a test report	VTYTESTREPORT01

Note minimum order quantities.